

Let's make a hanging light!

Materials

Make sure you have everything you need!

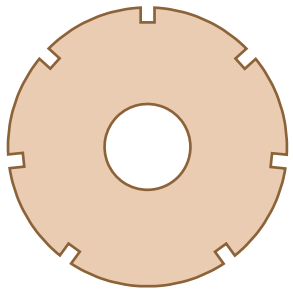

Top of Light

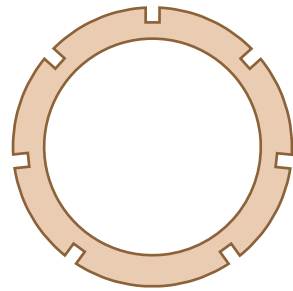

Bottom of Light

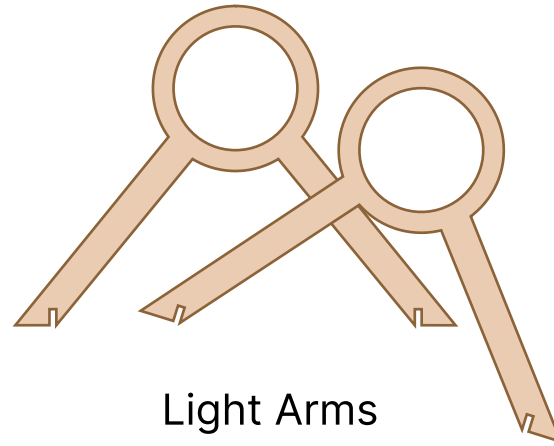

Light Arms

There should be 12 of these!



Colored Cellophane

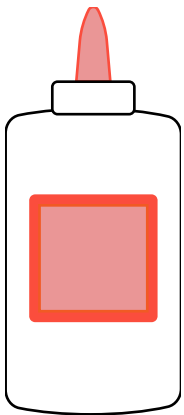

Glue

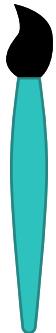

Paintbrush

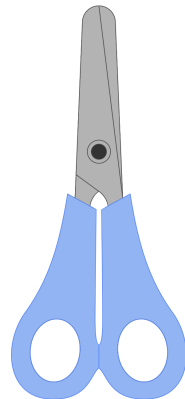

Scissors

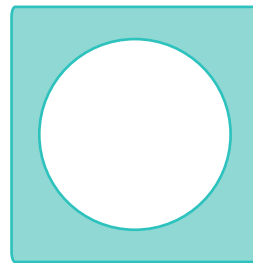

Circle Stencil

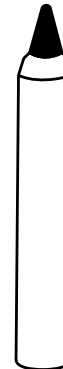

Marker



Light Bulb

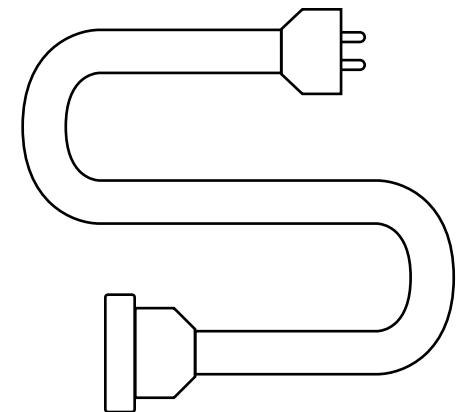

Light Cord

1

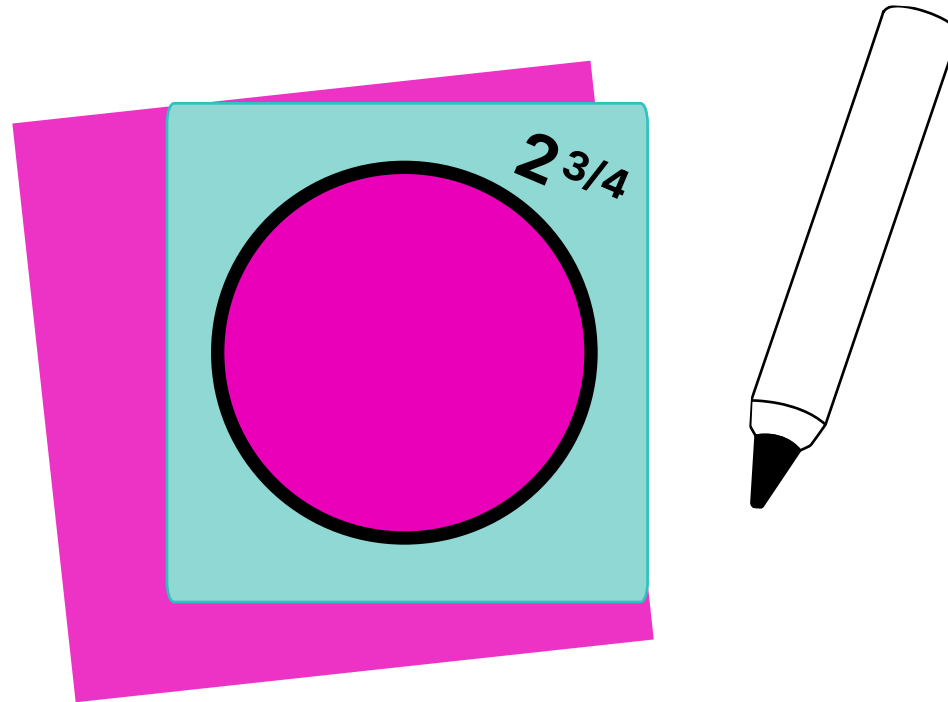

Pick out one piece of colored cellophane.

Using the circular stencil, draw a $2\frac{3}{4}$ inch circle on top of the cellophane.

2

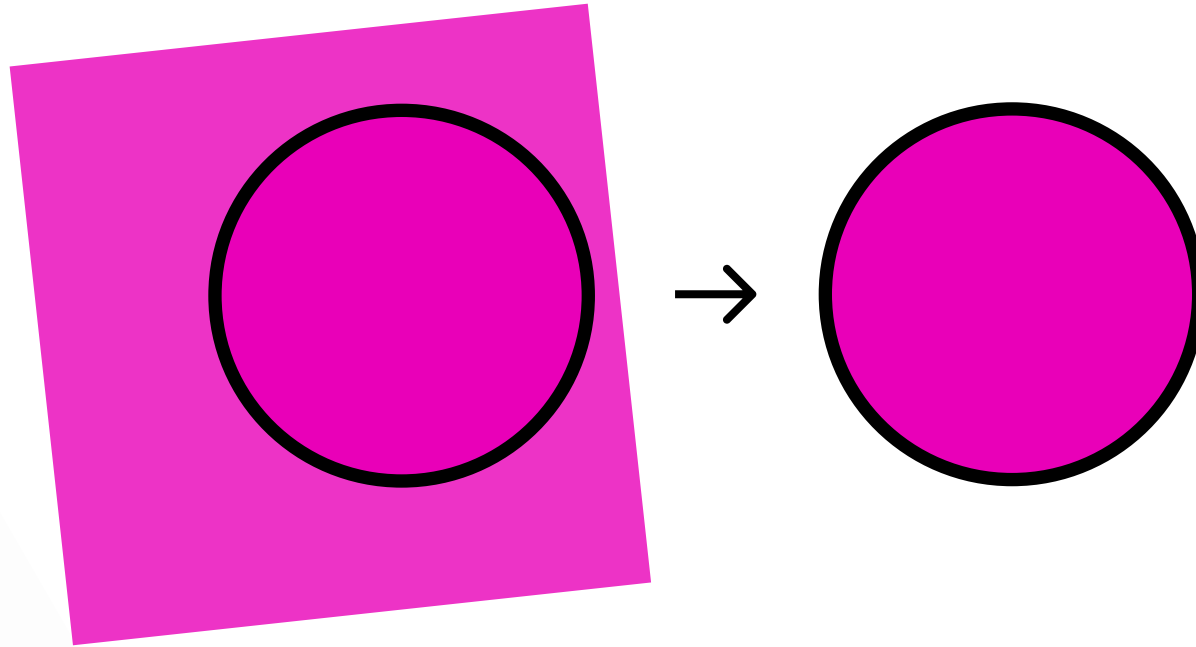
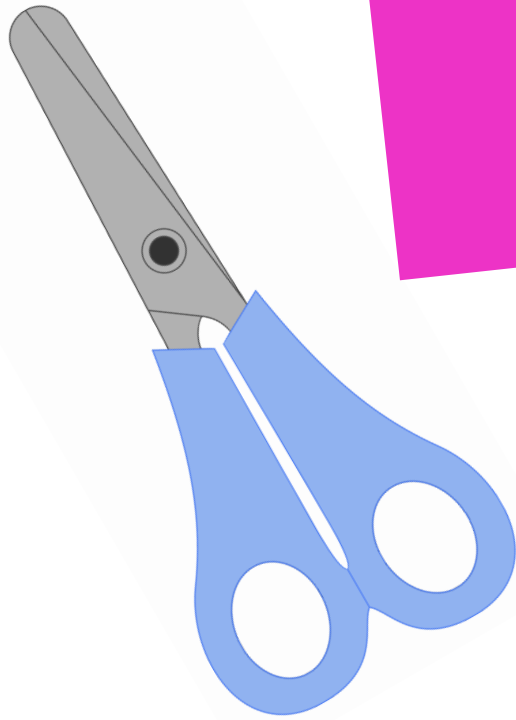

Cut out the circle.

You don't need to be precise,
the edges will be hidden!

*If you want to save time later, you can stack 6 on top of
each other and cut all of your circles out at the same time!*

3

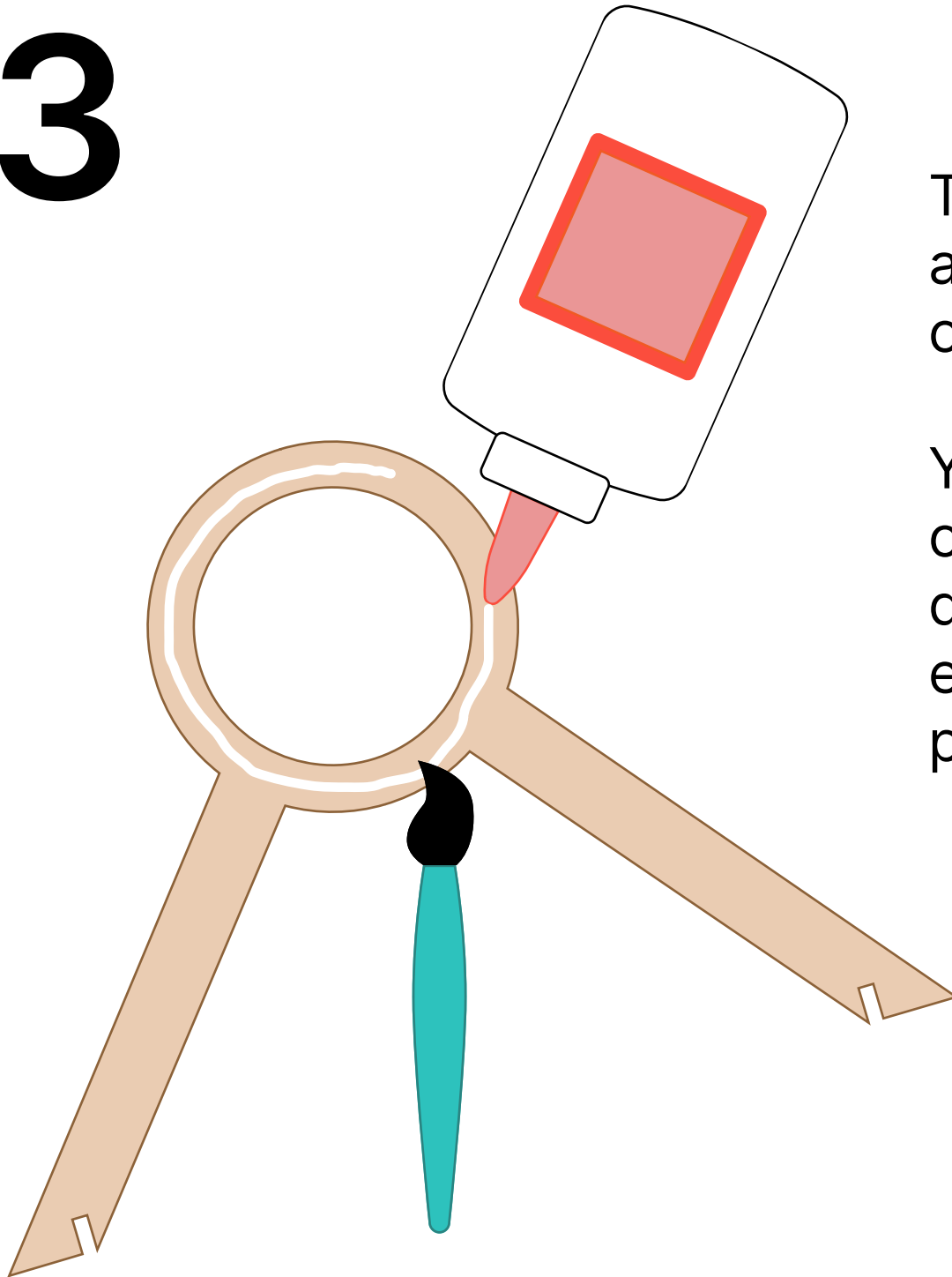

Trace a line of glue around the open circle of one arm.

You only need a little bit of glue, make sure it doesn't go over the edges! You can use your paintbrush to be precise.

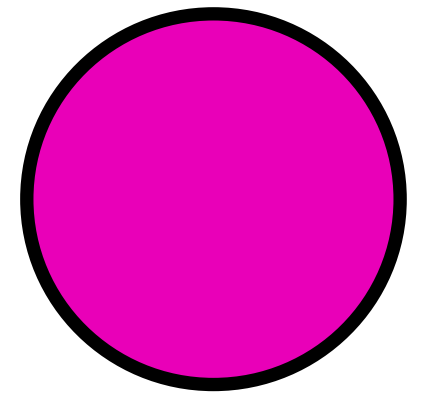

4

Lay the cellophane circle on top of the circle of glue and press down on the edges.

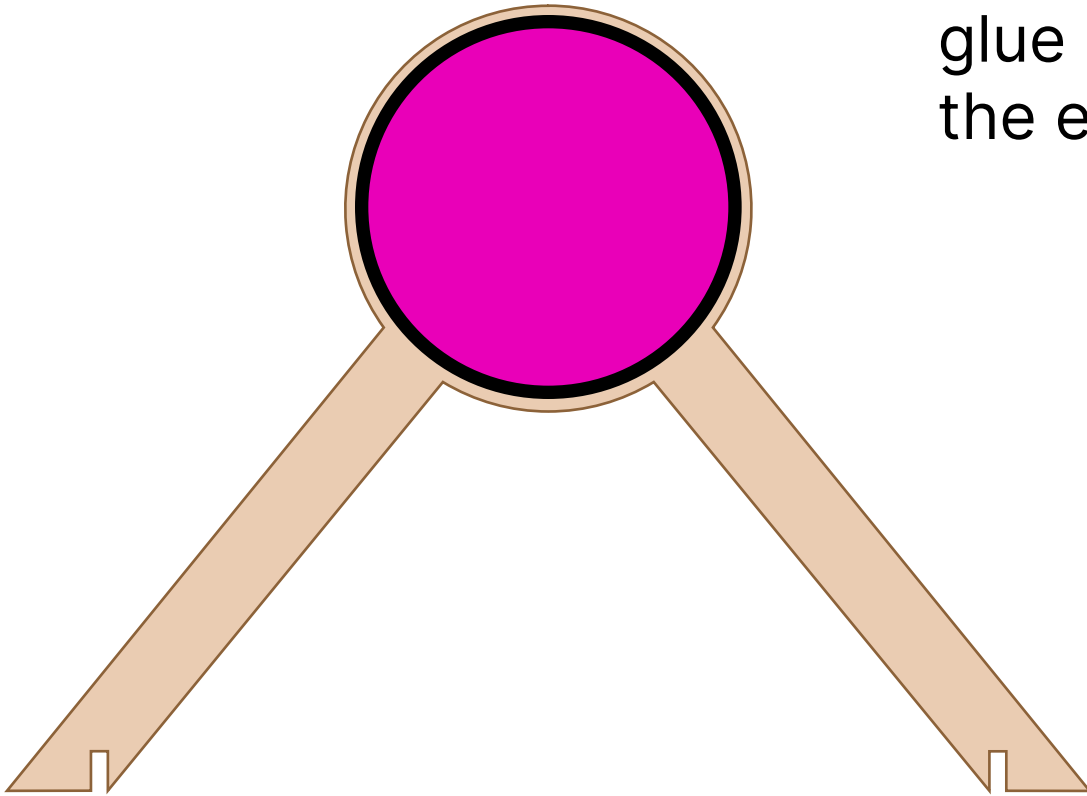

5

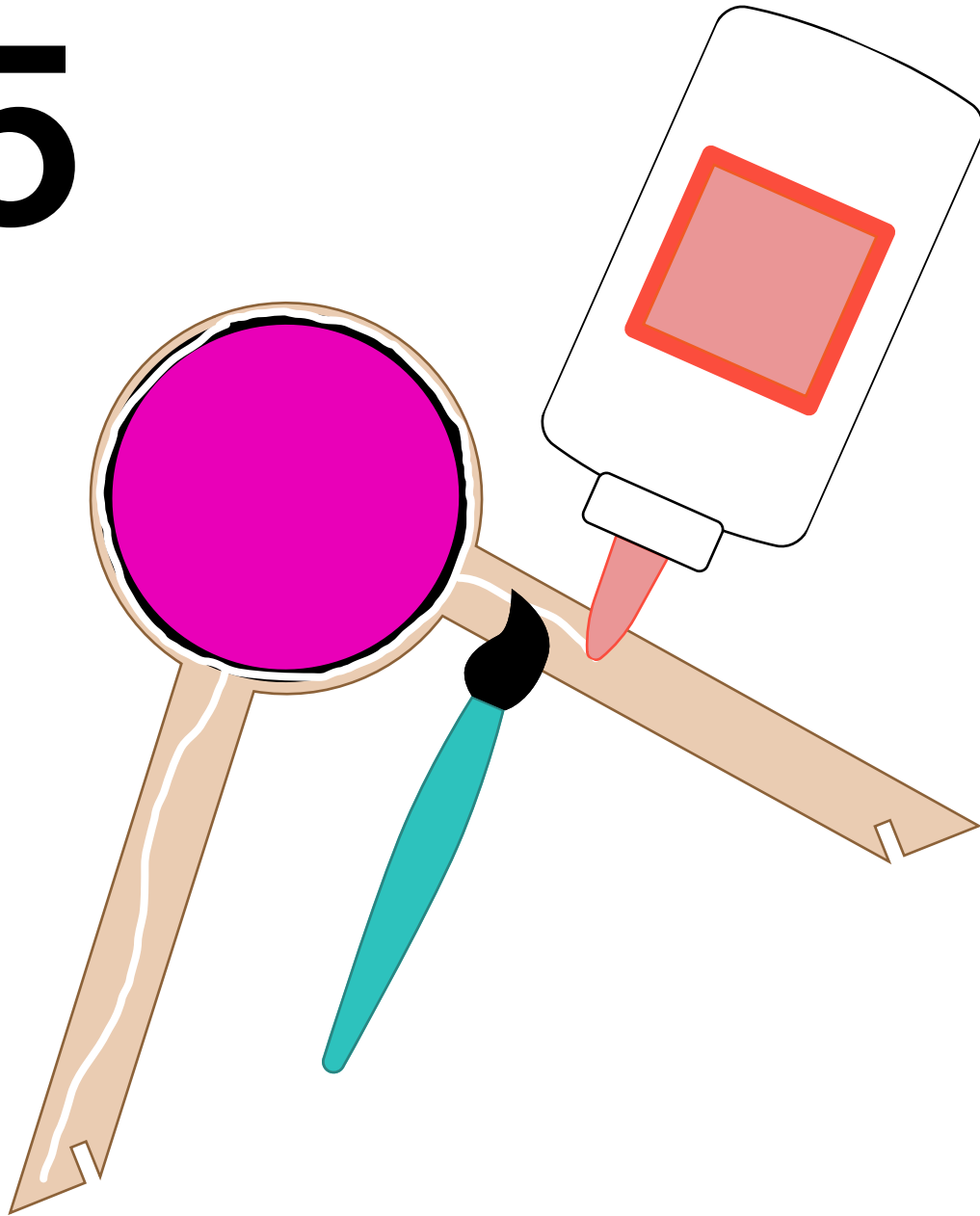

Trace a second line of glue around the edge of the cellophane and down the arm.

Remember, you don't need too much glue, and it's important to be precise!

6

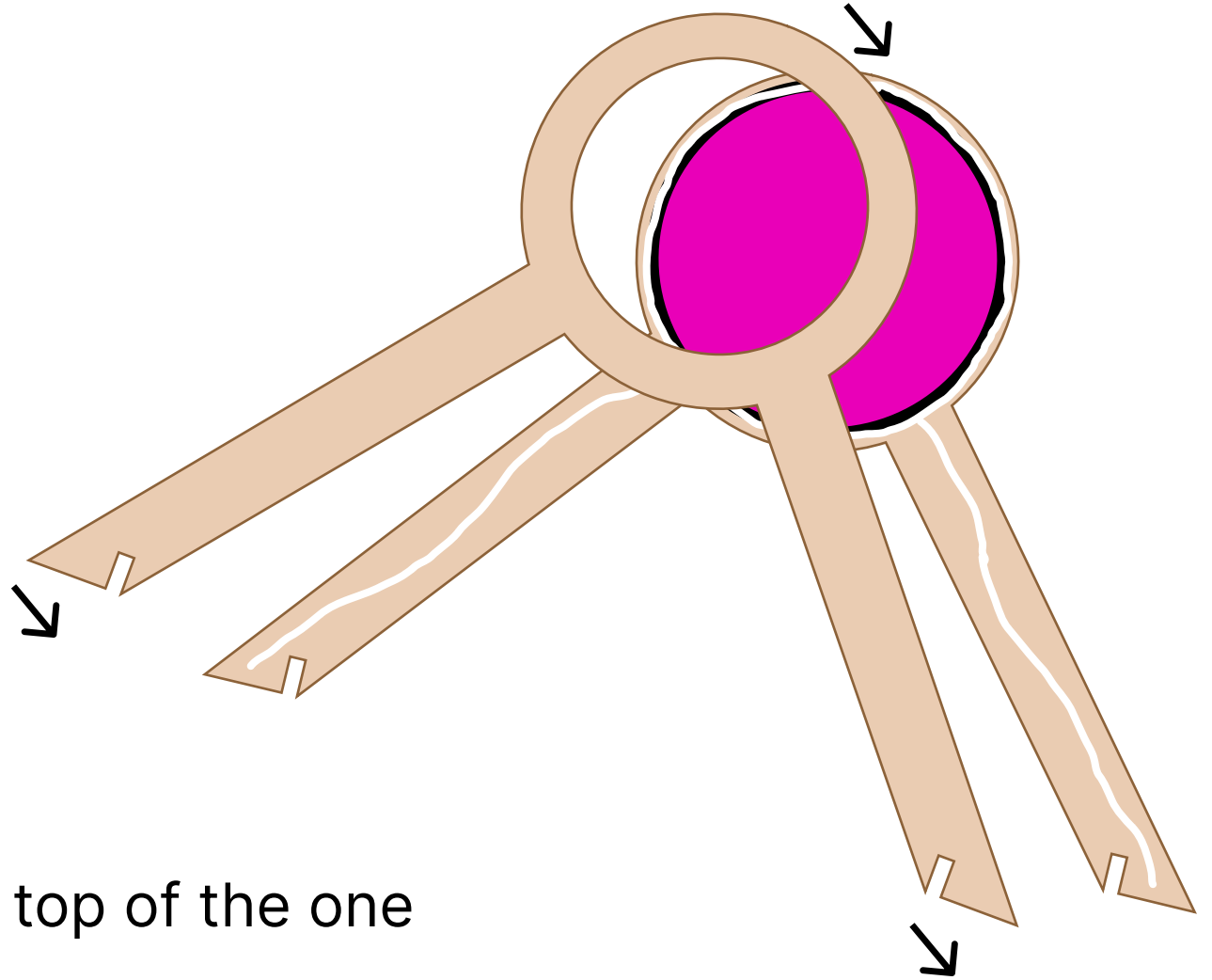

Place a new arm on top of the one you just glued.

Make sure the cellophane is facing inward, sandwiched between both arms so the edges are hidden!

7

Press the two arms together to ensure they stick!

Then, set aside to dry. It should be dry within a few minutes.

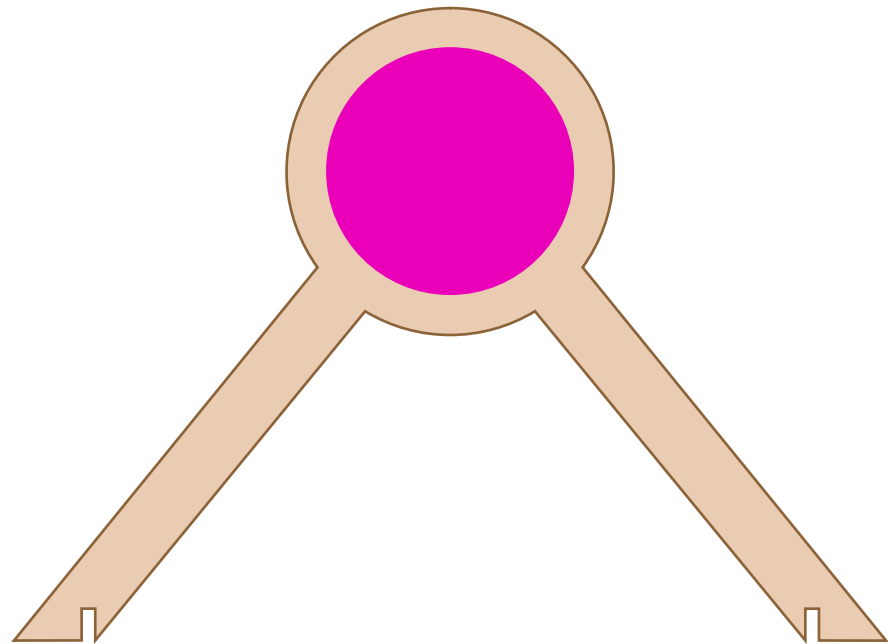

8

Repeat steps 1 through 7 until you have six complete light arms.

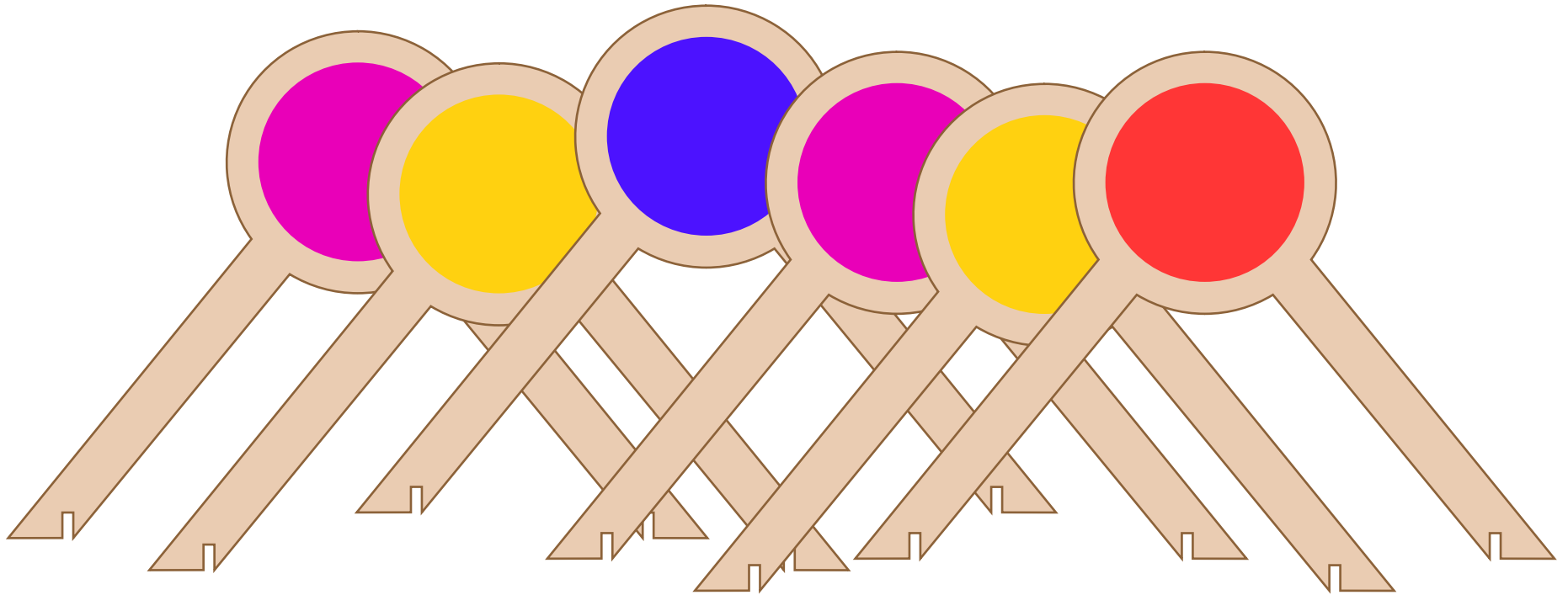

Now it's time to connect the arms to the top and bottom pieces of the light.

There are seven small cut outs on the top and bottom pieces, one for each arm, and each has its own color.

Each arm should be attached to its matching color cut out on the top and bottom pieces.

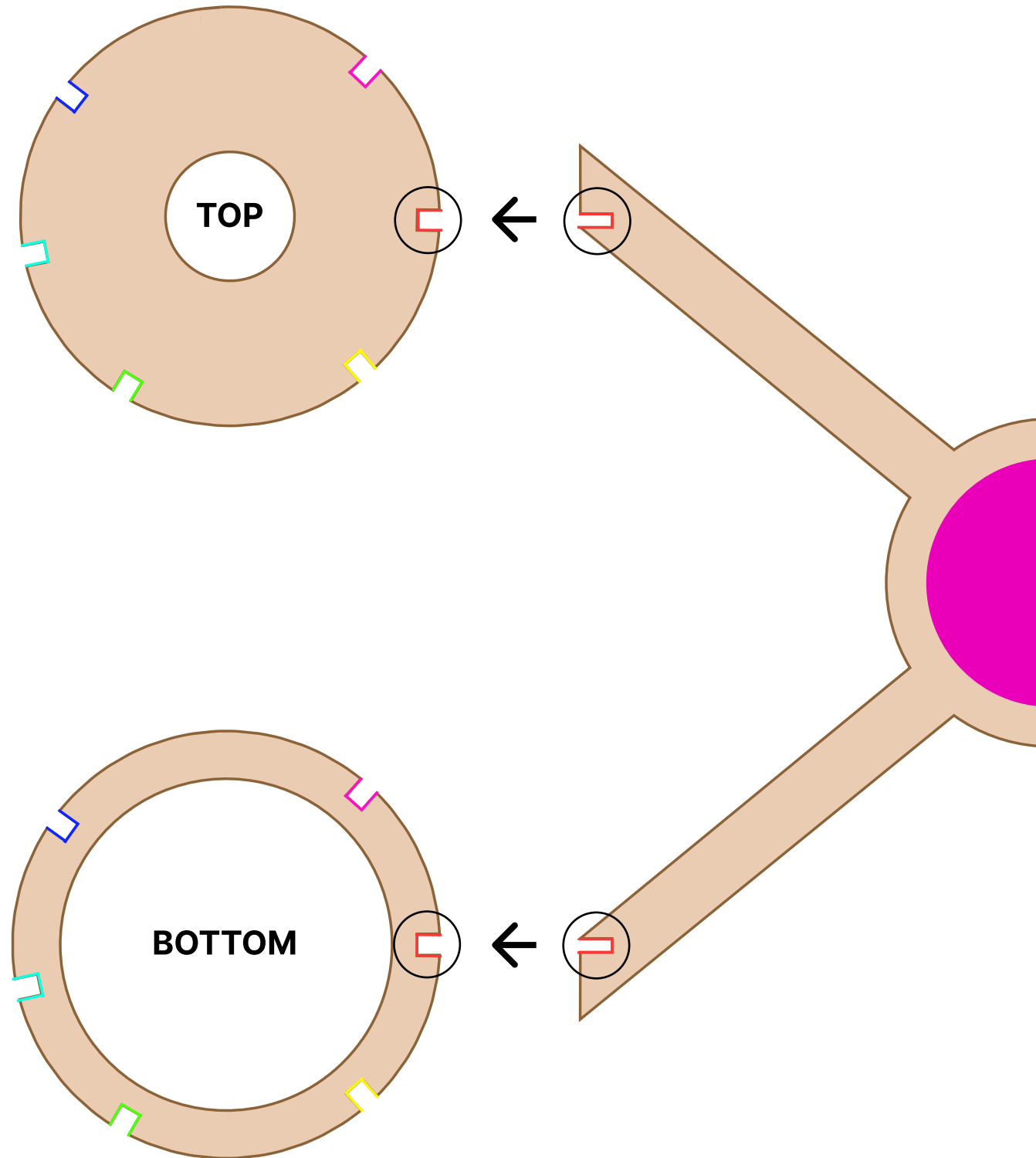

9

Slide one arm onto the top and bottom lamp pieces.

Make sure that you are matching up the colors!

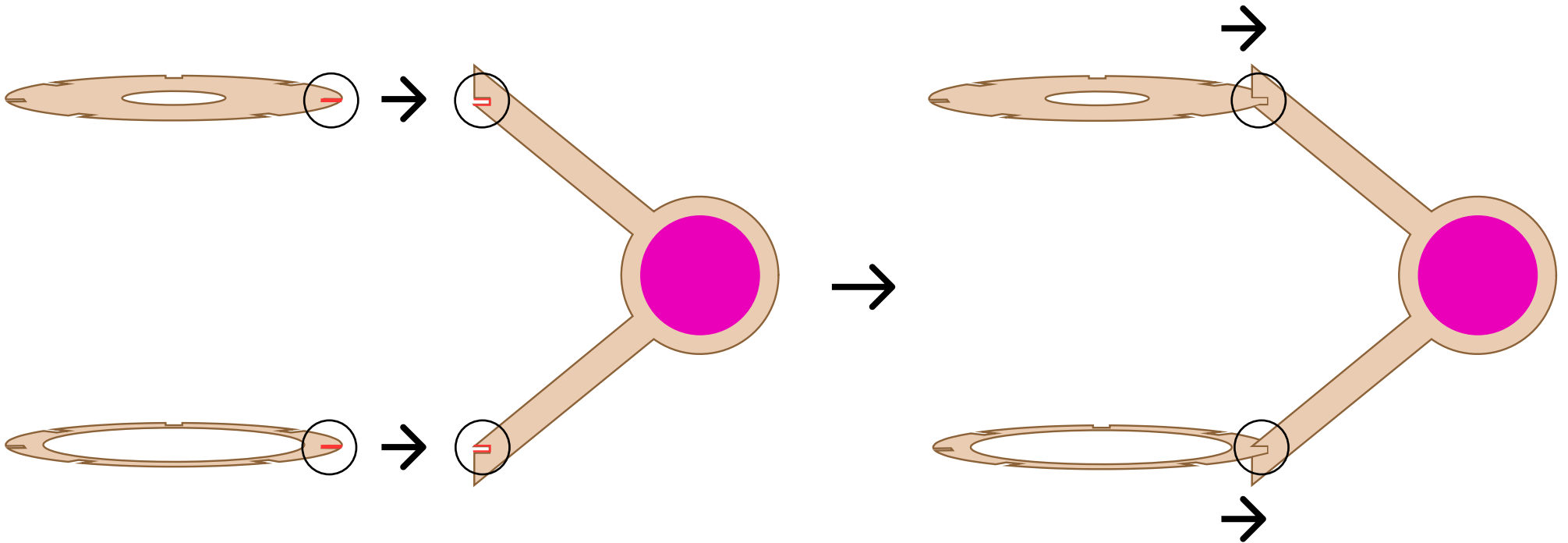

10

Repeat this step until all of your arms are connected to the top and bottom pieces of the light.

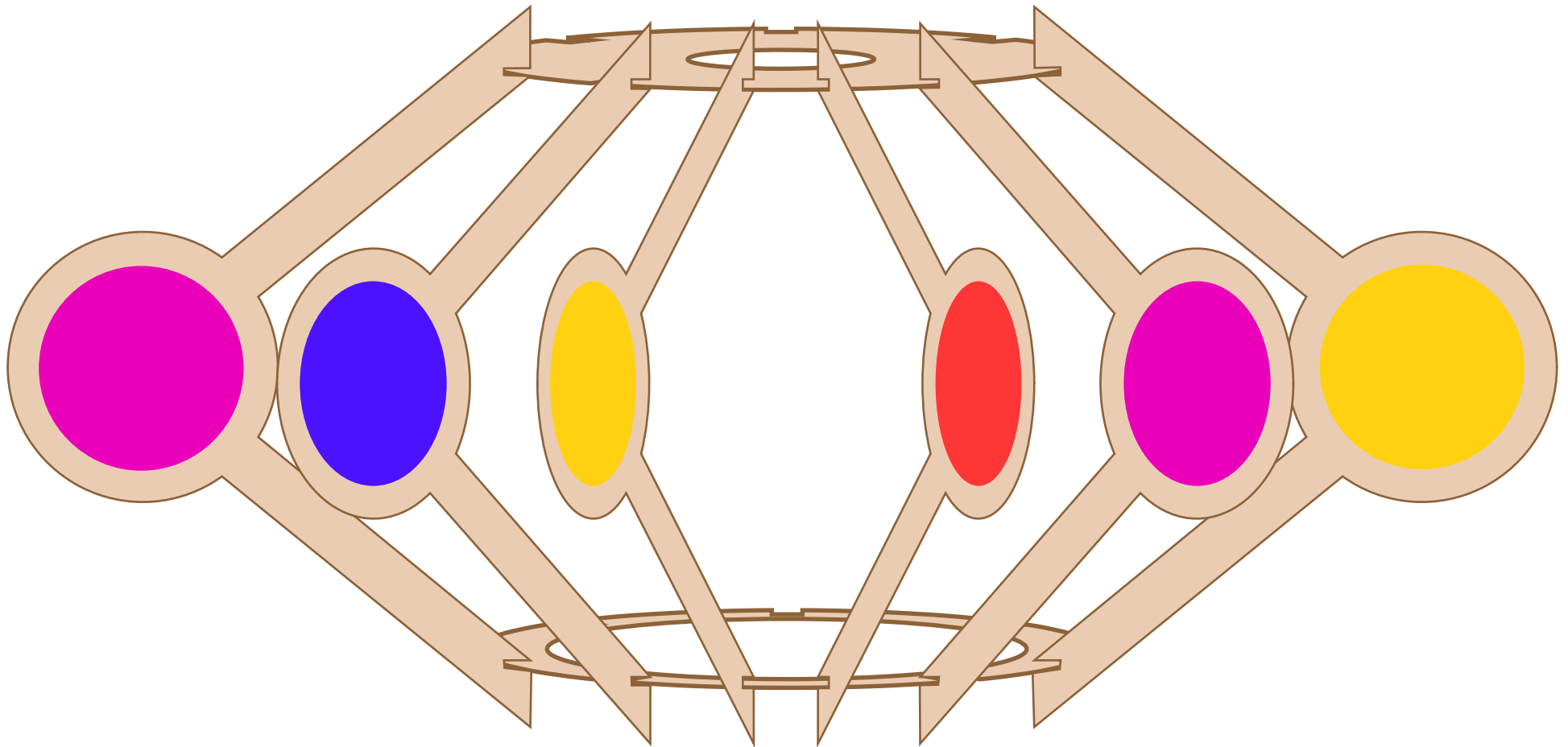

11

Now it's time to attach the electric cord for the light.

First, you'll need to unscrew the bottom piece of plastic.

Spin it off by twisting it counter clockwise.

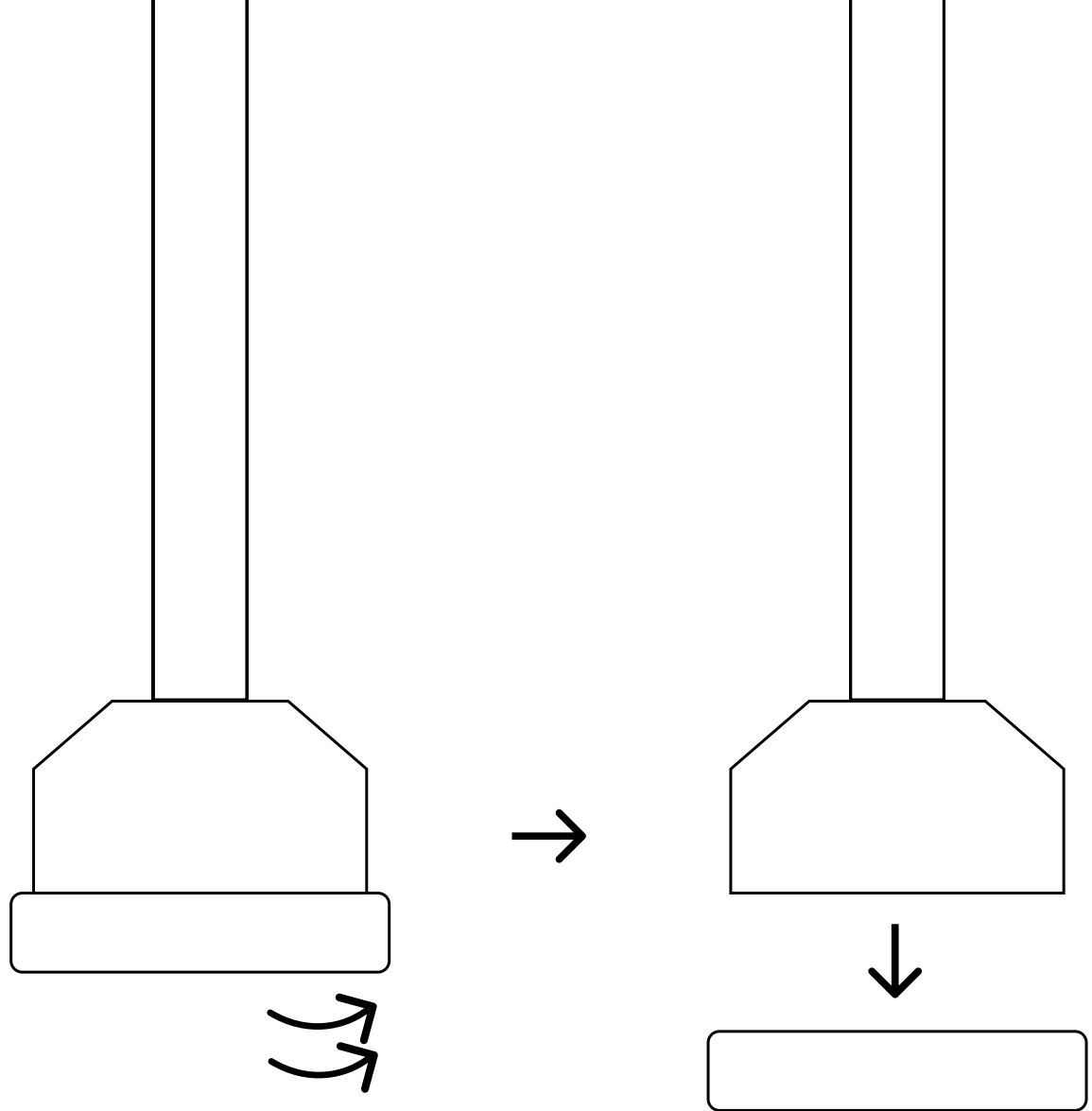

13

Secure the lamp between the top and the bottom of the cord fixture and screw the bottom piece back on by spinning it clockwise, securing the lamp in place.

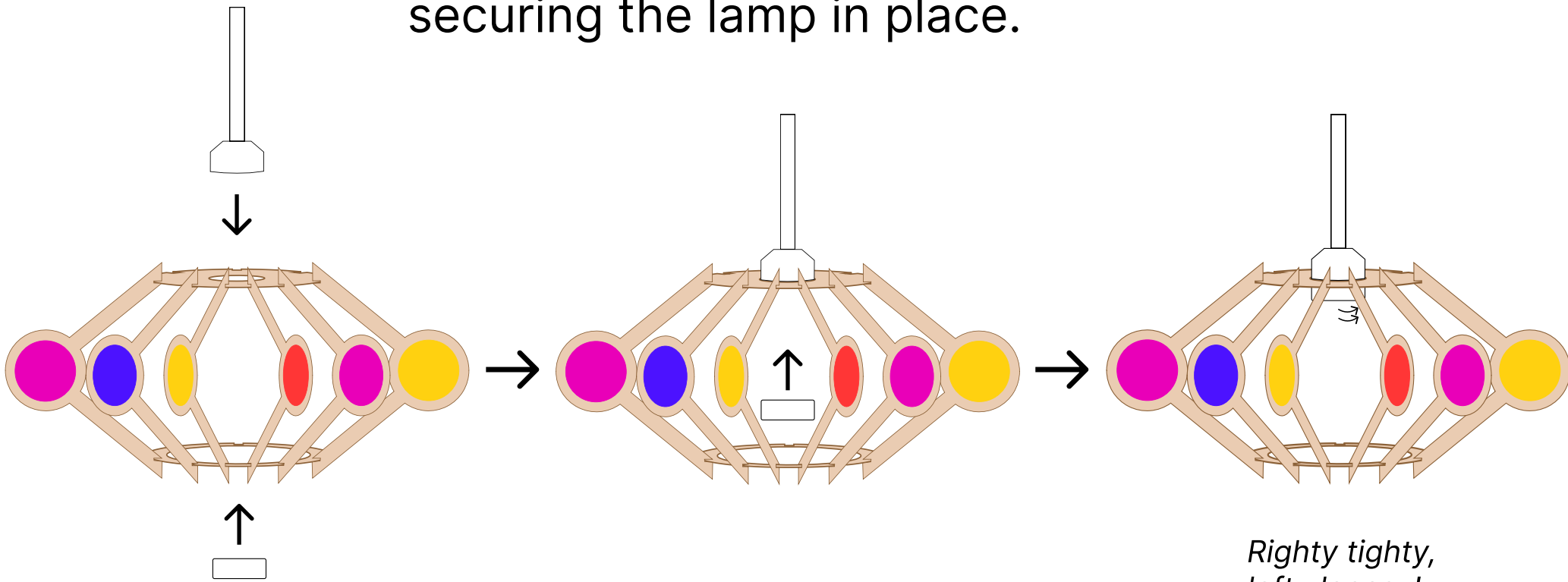

14

Screw in the light bulb by spinning it counter-clockwise into the bottom of the light cord fixture.

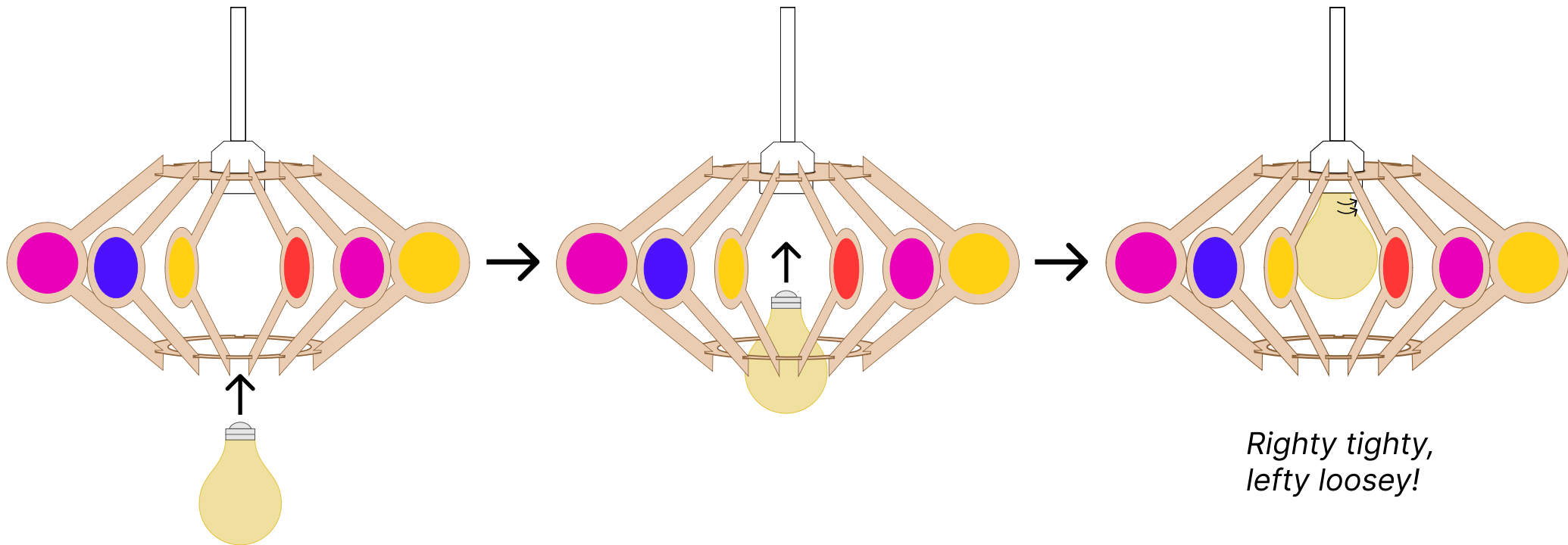

15

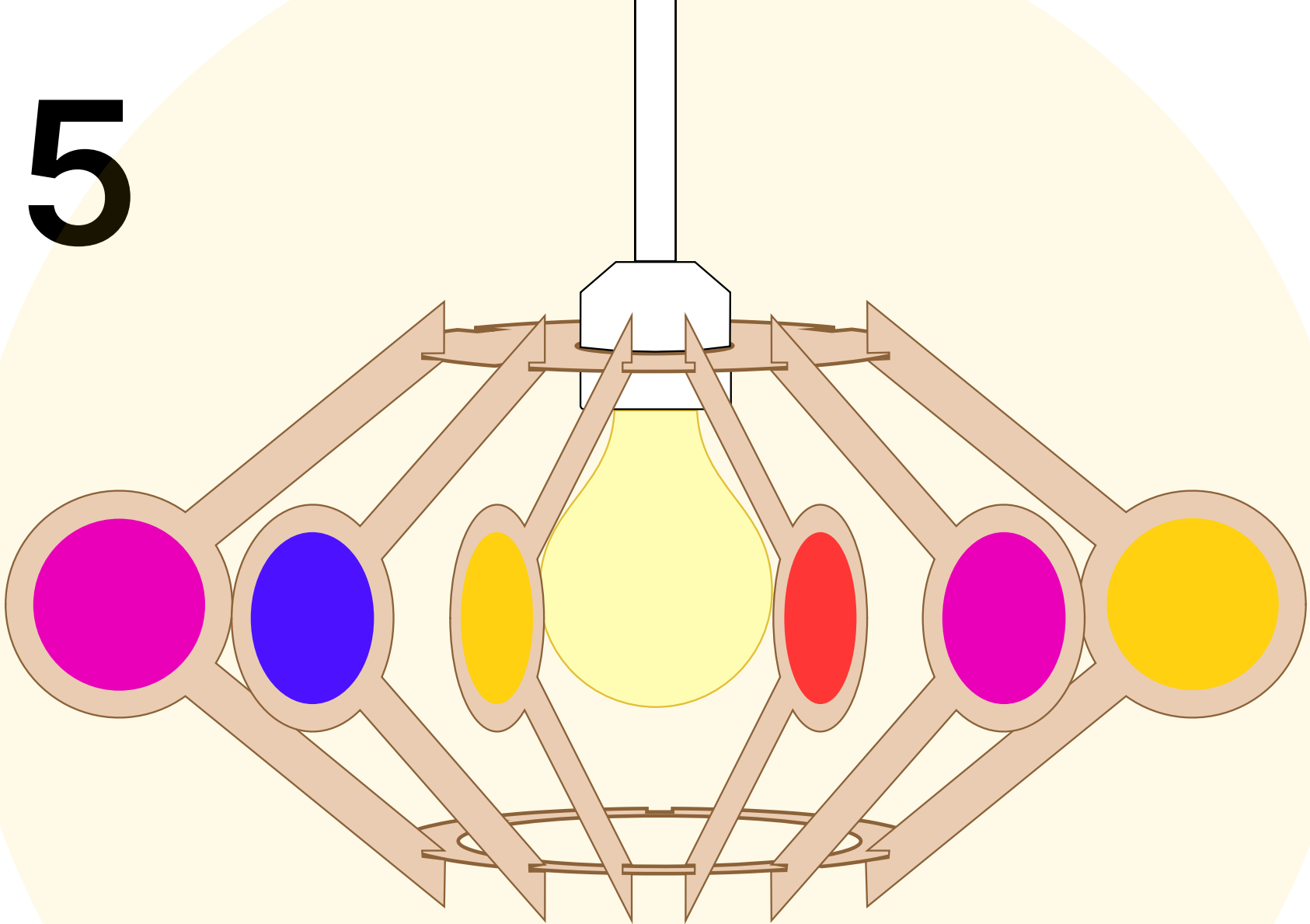

Time to hang it
up, plug it in,
and turn it on!